

50/51-G2 Outdoor Station Instructions

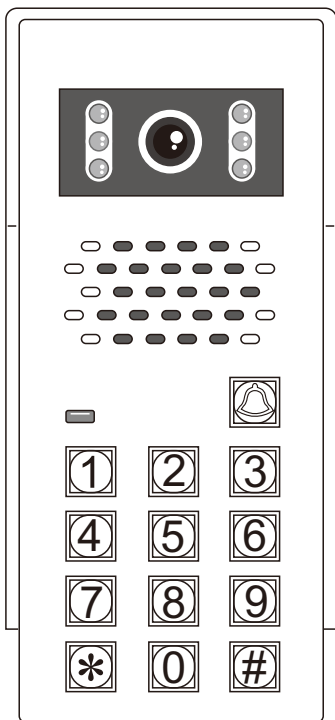

50

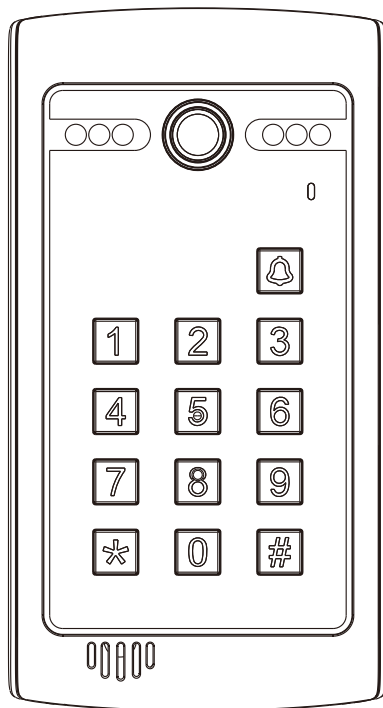

51

Schematic Diagram

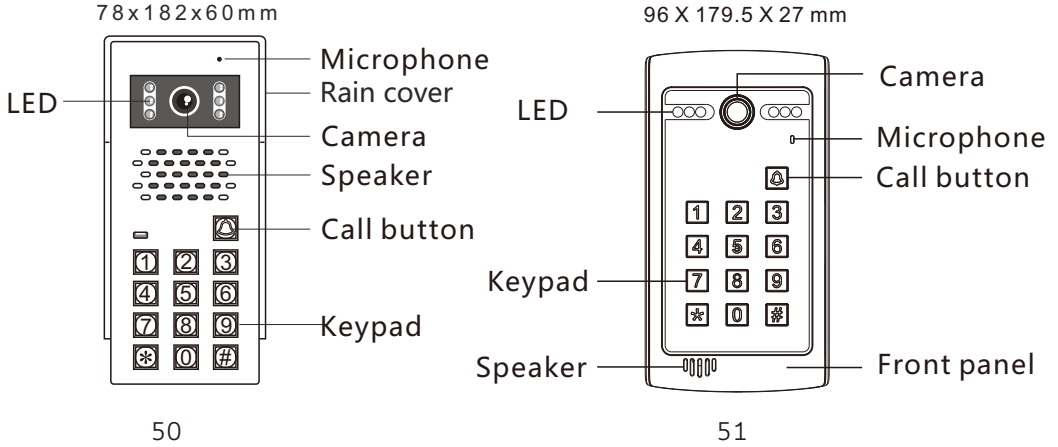

Wiring diagram

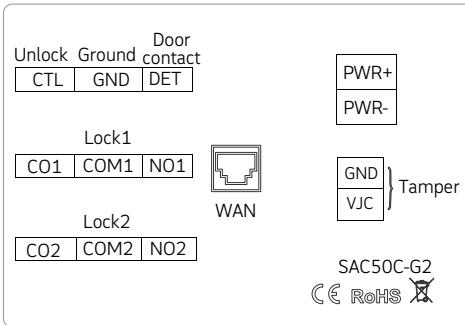

Notice: Unlock button is for lock 1

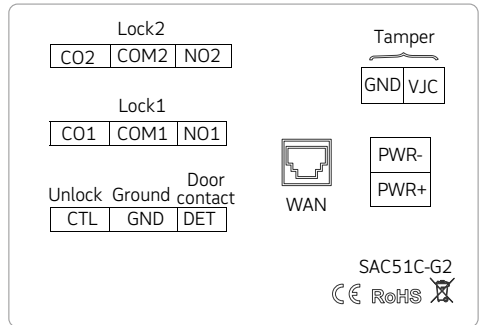

Notice: Unlock button is for lock 1

Basic functions

1. Keyboard operation
2. External unlock button connection
3. External anti-dismantling alarm function connection
4. Double relay output
5. Password unlock, capacity: 40 sets of passwords
6. Mobile APP unlocking and monitoring

Specifications

Power supply	DC 17V
IP rating	65
Operating temperature	-20°C -- 55°C
Installation	Wall mounted

System Architecture Diagram

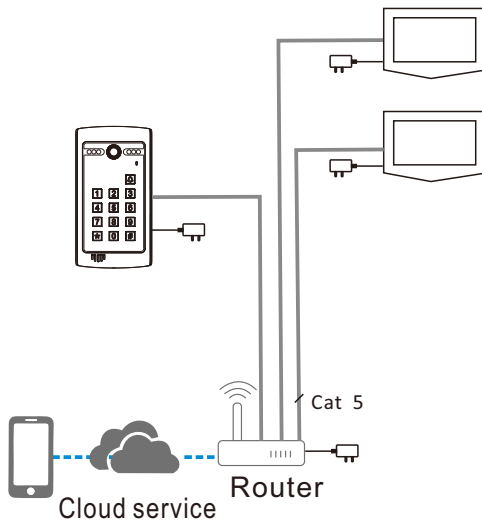

Notice: Indoor monitor connects to the power and network first.

After the indoor monitor is started, outdoor station SAC50\51-G2 connects to the power and network.

Installation

50

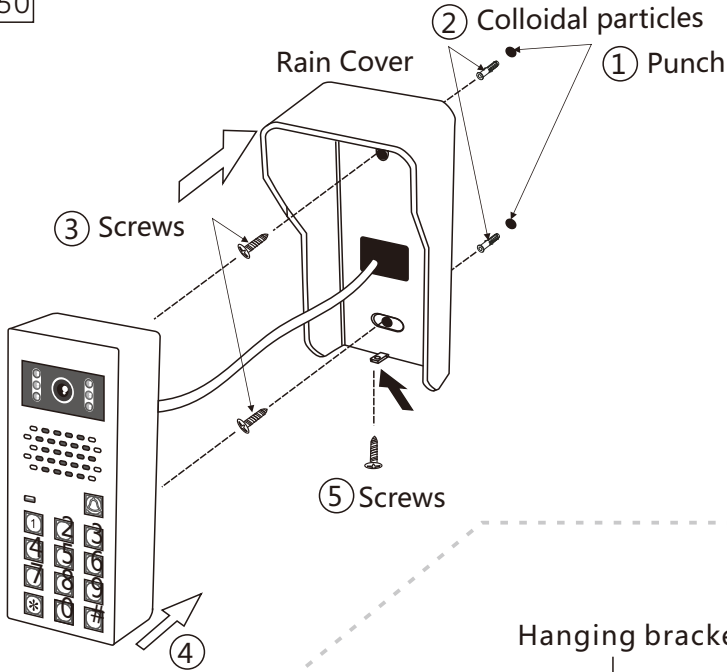

51

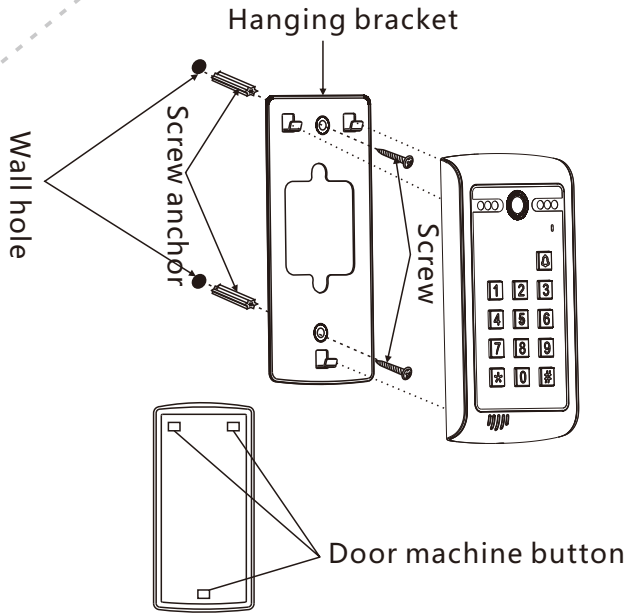

Installation mark → Insert screw anchor → Fixed hanging bracket
→ Align the buckle and hang it

Operation method

Password to open the door



Input password# to unlock door.

Call indoor monitor

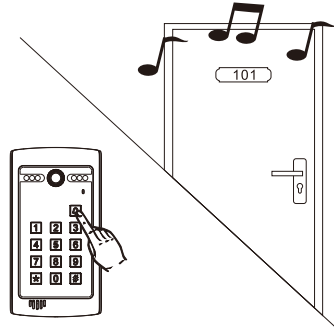

Press  to call indoor monitor.

Call mobile phone

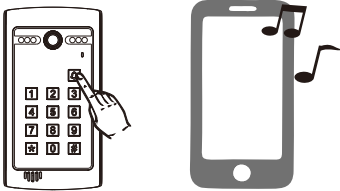

Press  to call phone.

Call Android indoor monitor

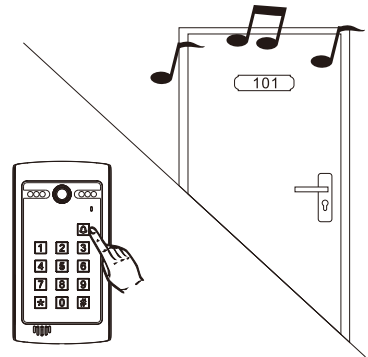

Press  to call android indoor monitor.

Password setting

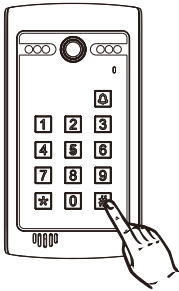

Note :

- 1、 Default setting password:1234.
- 2、 Enter the setting mode, then set unlocking password.
(Maximum 40 unlocking password. Password digit: 2-6 digit)
- 3、 Setting an unlock password will fail under these conditions:
 - a. The reverse of password is the same. For example, 1221.
 - b. It is the same as the technician password.
 - c. It clashes with another unlock password or is the reverse of another unlock password
- 4、 Unlocking password unlock the first lock.

----- Modify setting password in the setting mode -----

- 1.Press #4-digit setting password#. (Indicator sound "Di")
- 2.Press new 4-digit setting password # . (Indicator sound "Di")
- 3.Press* to exit modification mode.

Notice : Indicator sound "DeDe " for wrong operation.

----- Set unlock time (Default unlock time 5 seconds) -----

1. Press * 4-digit setting password to enter the setting mode (Indicator sound "Di" , LED light is on)
2. Press 00 (Indicator sound "Di") , then press 2-digit unlocking time from 1--99 seconds) (Indicator sound "Di")
- 3.Press* to exit setting mode.

----- Add unlock password by different places -----

- 1.Enter to the setting mode first. (Press * 4-digit setting password)
- 2.Press figure 01(start from 01 to 40) as the first password place (Indicator sound "Di"). Then enter unlock password #. (Indicator sound "Di")
- 3.Press* to exit setting mode.

Notice : Indicator sound "DeDe " for wrong operation.

----- Delete unlock password by different places -----

1. Enter to the setting mode first. (Press * 4-digit setting password)
2. Press the 2-digit place code for deletion. (Indicator sound "Di")
3. Press # to confirm the deletion of the unlocking password in this place.
(Indicator sound "Di")

4. Press * to exit modification mode.

Notice : Indicator sound "DeDe " for wrong operation.

----- Delete unlock password directly -----

1. Enter to the setting mode first. (Press * 4-digit setting password)
2. Press # (Indicator sound "Di"). Enter unlocking password #. (Indicator sound "Di")

Notice : Indicator sound "DeDe " for password that does not exist.

3. Press * to exit modification mode.

----- Restore default setting -----

1. Enter to the setting mode first. (Press * 4-digit setting password)
2. Press # (Indicator sound "Di"). Then press # (Indicator sound "Di").
3. Press 7 times of # to restore default setting (Indicator sound "Di").

4. Press * to exit modification mode.

Notice : This operation cannot reset to default setting password.

----- Reset the default setting password -----

1. After the outdoor station is powered off and powered on again, a beeping sound will be emitted.
 2. Then press the "*" key 5 times continuously within one minute, and the outdoor station will send out a beeping sound.
- At this time, the reset password is successful, and the setting password is restored to 1234.

----- Modify the extension number -----

1. Enter to the setting mode first. (Press * 4-digit setting password)
 2. Press "9" twice, the door will make a beeping sound
 3. Enter the two-digit extension number, such as: 02, the door machine will make a beeping sound.
- At this time, the extension number of the second outdoor station is successfully modified.

CCL-SH APP Operation

1、 CCL-SH APP download and installation

Method 1 : Scan the QR code to download CCL-SH APP.



Method 2 : Android: Google Play , search CCL-SH app.

iOS: App Store, search CCL-SH app.

Notice : 1. Android running version 6.0 and above.

2. iOS running version 9.0 and above.

2、 CCL-SH APP register

▲Open CCL-SH app (Image 1) , and click create account.

▲Fill out and complete the registration (User name, password, email, cell phone number)(Image2)

Notice: Please remember your password !

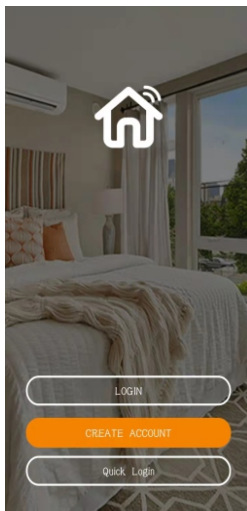

(Image1)

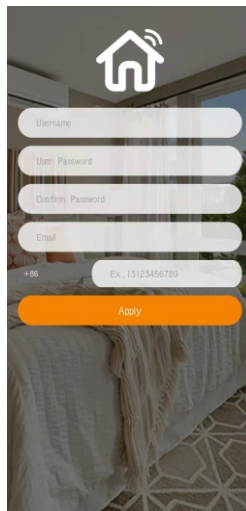

(Image2)

3、CCL-SH APP and add outdoor station

▲Click  on the upper left corner (Image 9).

▲Scan the QR code of the outdoor station to bind the device (Image10) .

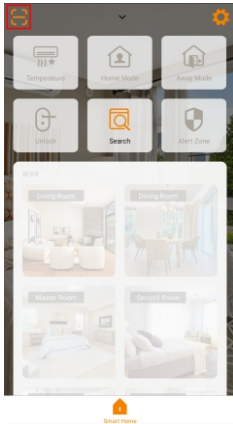

(Image 9)

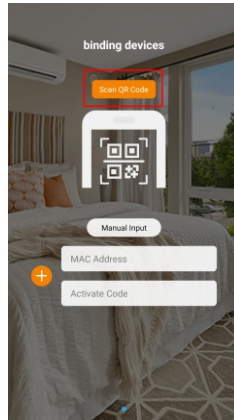

(Image 10)



QR code of outdoor station

▲Binding succeeded : “  Outdoor C04LD-00231631980D ” (Image 11)

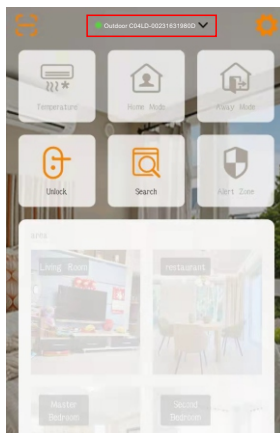

Green light  : The outdoor station is online status.

Red light  : The outdoor station is offline status.



(Image 11)

4、CCL-SH APP to unlock door

- ▲Click  (Image 12). Pop-up dialogue box.
- ▲Click  to unlock the first lock (Image 13)
- ▲Click  to unlock the second lock (Image 14)

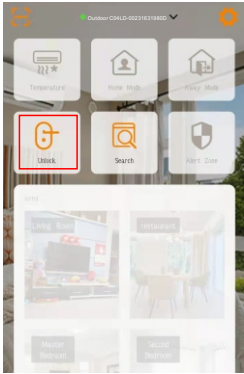

(Image 12)

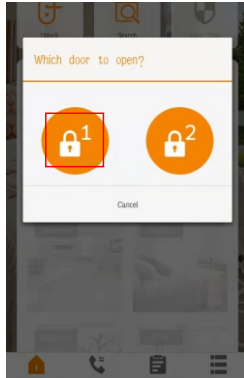

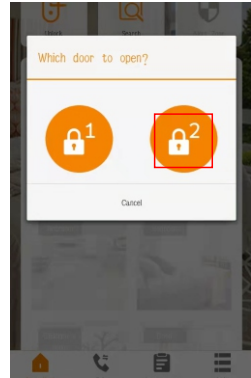

(Image 13)



(Image 14)

5、Intercom setting

- ▲Click  on the upper right corner (Image 15)
- ▲Click “  Cloud Call Setting ” (Image 16)
- ▲The mobile phone number is the registered phone number.
Enter room number 0101 and click bind (Image 17).
Notice: For villa system, room number is 0101 only.

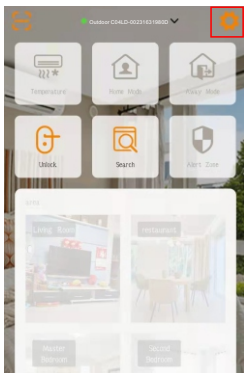

(Image 15)

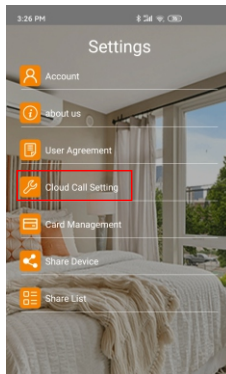

(Image 16)

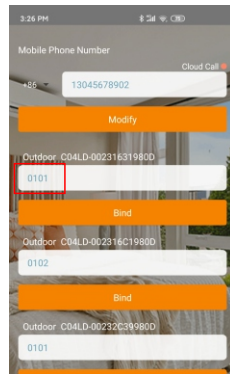

(Image 17)

6、Intercom

▲Outdoor station and indoor monitor

Press call button  , indoor monitor and app will ring separately.

▲Outdoor station and Android indoor monitor

Press call button  , indoor monitor and app will ring separately.

▲Outdoor station only

Press call button  , app will ring.

▲Main interface of intercom (Image 12)

①.A visitor' s picture

②.Press  to pick up the call and talk with the visitor

③.Press  to hang up the call

④.Press  to open the first door

⑤.Press  to open the second door

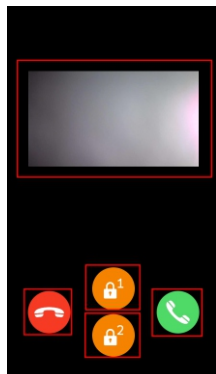

(Image 18)

▲ Check visitors' pictures

Click  (Image 19), click date and check pictures (Image 20, 21 and 22)



(Image 19)

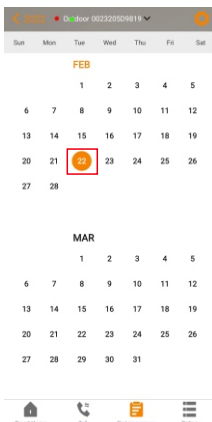

(Image 20)

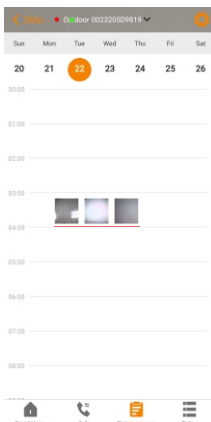

(Image 21)

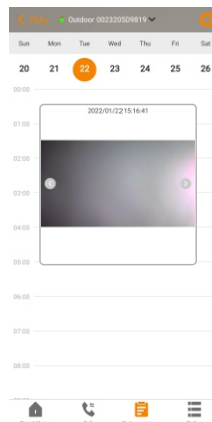

(Image 22)

7、Monitor

Press 

▲ Monitor from the camera of the outdoor station

▲ Talk with the visitor by the outdoor station

▲ Click  to unlock the first lock (Image 23)

▲ Click  to unlock the second lock (Image 23)

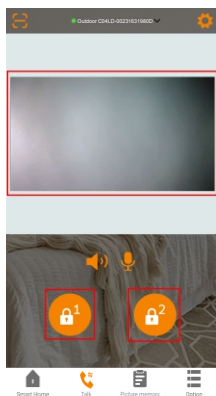

(Image 23)

8. Authorize new users

Method 1: Scan QR code

▲ Click  on the upper right corner

▲ Click **Share Device** (Image 25)

▲ Scan new user's QR code in the CCL-SH app. Choose the device to be authorized.

Click OK (Image 26)

Choose the time to be authorized. Click OK (Image 27).

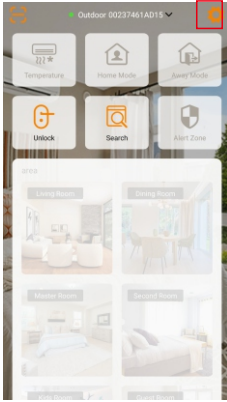

(Image 24)

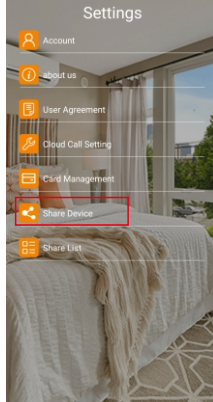

(Image 25)

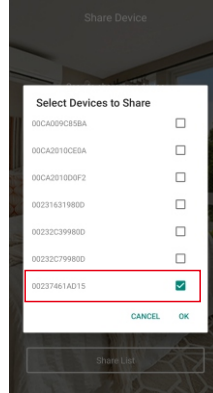

(Image 26)

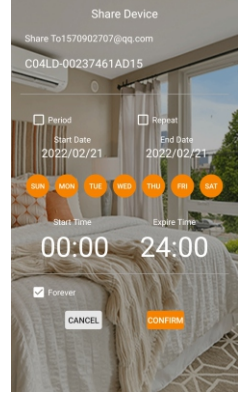

(Image 27)

Notice: How to find new user's QR code in the app?

▲ Click  on the upper right corner (Image 28).

▲ Click **Share Device**

▲ Click **My Share Code** (Image 30). This is the user QR code (Image 31).

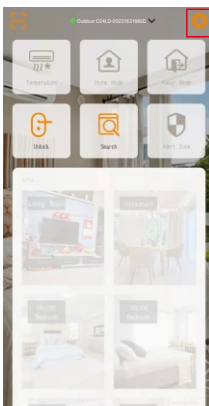

(Image 28)

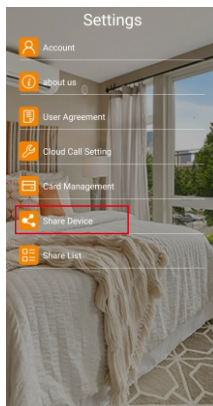

(Image 29)

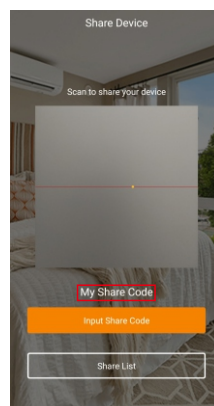

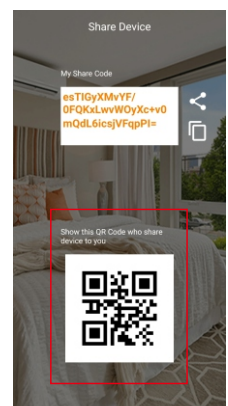

(Image 30)



(Image 31)

Method 2 : Enter new user 's share code

- ▲ Click  on the upper right corner (Image 32)
- ▲ Click  Share Device (Image 33)
- ▲ Click **Input Share Code** (Image 34)
- ▲ Paste the new user 's share code (Image 35)

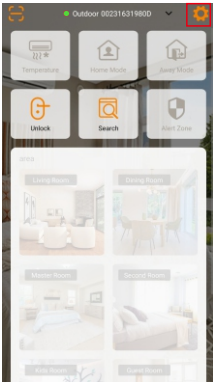

(Image 32)

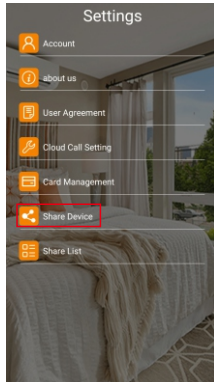

(Image 33)

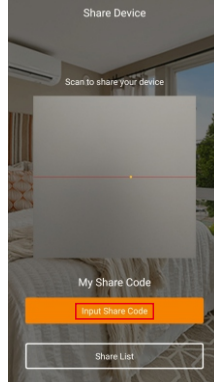

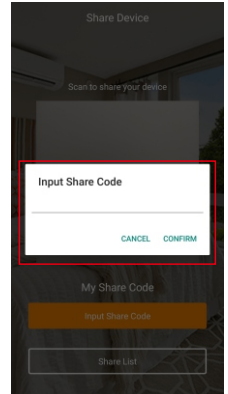

(Image 34)



(Image 35)

Notice: How to find new user 's share code in the app

- ▲Click  on the upper right corner (Image 36).
- ▲Click  Share Device
- ▲Click **My Share Code** (Image 38). This is the user share code (Image 39).

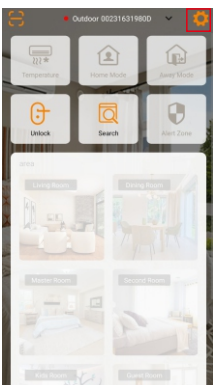

(Image 36)

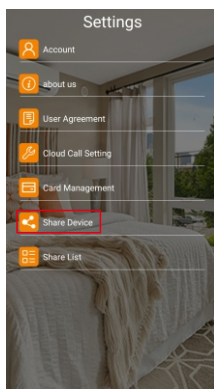

(Image 37)

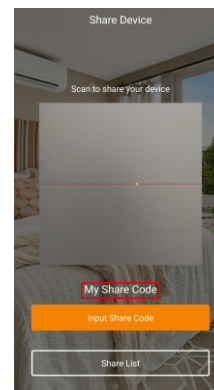

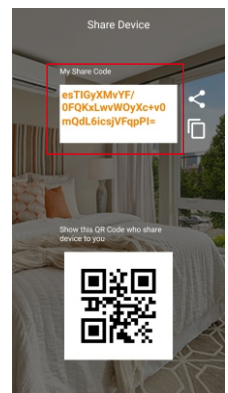

(Image 38)



(Image 39)

9、 List of the new users

▲Click  on the upper right corner (Image 40)

▲Click  Share List (Image 41) to check the list of the new users of this device.

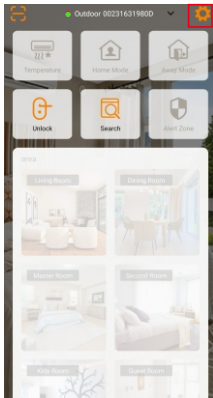

(Image 40)

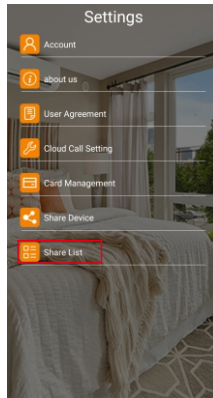

(Image 41)

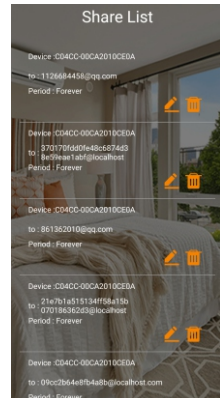

(Image 42)

▲Click  to modify (Image 43 & 44)



(Image 43)

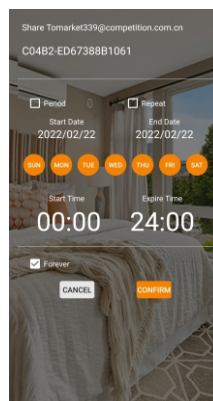

(Image 44)

▲ Click  to delete the share (Image 45)

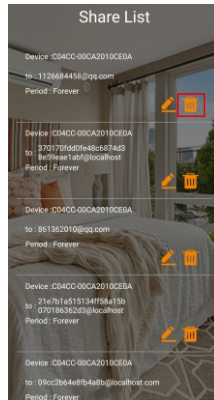

(Image45)

10、Delete device

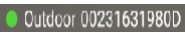
▲ Click  on the top of the front page. Choose the device for deletion (Image 46)

▲ Click  . Click  (Image 47)

▲ Click OK in the pop-up dialogue box (Image 48)

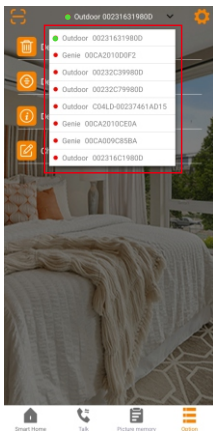

(Image46)

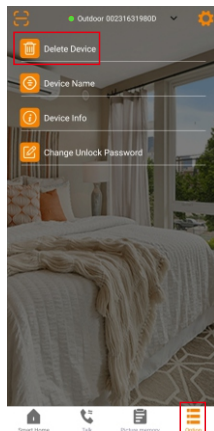

(Image 47)

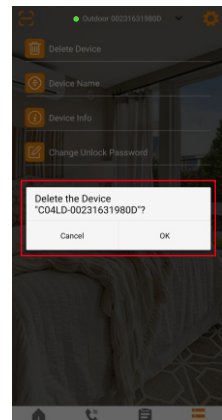

(Image 48)

11. Modify device name

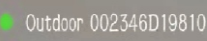
▲ Click  on the upper right corner and choose the device to change name (Image 49)

▲ Click  . Click  (Image 50)

▲ Enter the new name of the device (Image 51). Click SEND. The name is modified (Image 52).

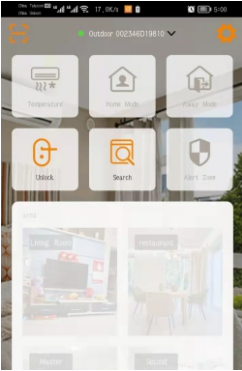

(Image 49)

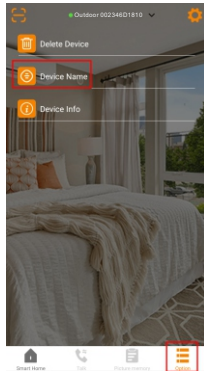

(Image 50)

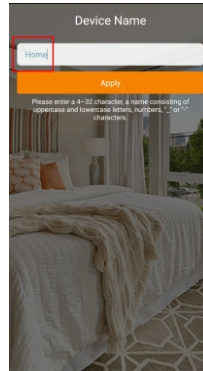

(Image 51)

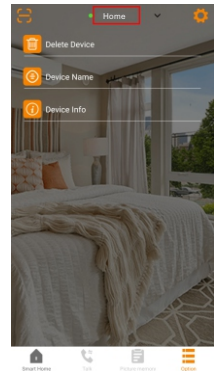

(Image 52)

12. Forget password

Forget login password ?

▲ Click  in the login page (Image 53)

▲ Enter email address or user name. Click SEND. The reset password email will be sent (Image 54).

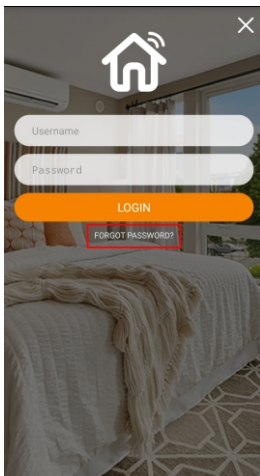

(Image 53)

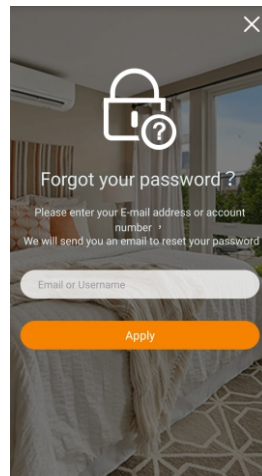

(Image 54)